

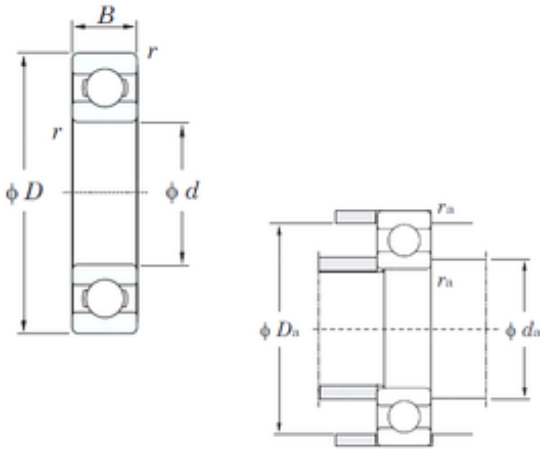

China 6202 Bearing Supplier



6200 Bearing 2D drawings and 3D CAD models

NSK SKF Timken Koyo NTN Deep Groove
Ball Bearing 6200 6201 6202 6203 6204 6205 6206
6207 6208 6209 6210 6211 6212 6213 6214 6215
2rscm/2RS/Zz/Zzcm/DDU/Dducum/C3

Bearing No. 6200

Size	10x30x9 mm
Bore Diameter	10 mm
Outer Diameter	30 mm
Width	9 mm
d	10 mm
D	30 mm
B	9 mm
C	9 mm
r min.	0,6 mm
da min.	14 mm
Da max.	26 mm
ra max.	0,6 mm
Weight	0,032 Kg
Basic dynamic load rating (C)	5,1 kN
Basic static load rating (C0)	2,4 kN
(Grease) Lubrication Speed	24000 r/min
(Oil) Lubrication Speed	29000 r/min
Category	Single Row Ball Bearings
Inventory	0.0
Manufacturer Name	KOYO
Minimum Buy Quantity	N/A
Weight / Kilogram	0.035
Product Group	B00308



China 6202 Bearing Supplier

Enclosure	Open
Precision Class	ABEC 1 ISO P0
Maximum Capacity / Filling Slot	No
Rolling Element	Ball Bearing
Snap Ring	No
Internal Special Features	No
Cage Material	Steel
Internal Clearance	C0-Medium
Inch - Metric	Metric
Long Description	10MM Bore; 30MM Outside Diameter; 9MM Outer Race Diameter; Open; Ball Bearing; ABEC 1 ISO P0; No Filling Slot; No Snap Ring; No Internal Special Features
Category	Single Row Ball Bearing
UNSPSC	31171504
Harmonized Tariff Code	8482.10.50.68
Noun	Bearing
Keyword String	Ball
Manufacturer URL	http://www.koyousa.com
Manufacturer Item Number	6200
Weight / LBS	0.076
Outer Race Width	0.354 Inch 9 Millimeter
Bore	0.394 Inch 10 Millimeter
Outside Diameter	1.181 Inch 30 Millimeter
Bearing No.	6200
r(min)	0.6
Cr	6.40
C0r	2.40
Cu	0.120
f0	13.2



China 6202 Bearing Supplier

Grease lub.	24000
Oil lub.	29000
da(min)	14
Da(max)	26
ra(max)	0.6
(Refer.)Mass(kg)	0.032